

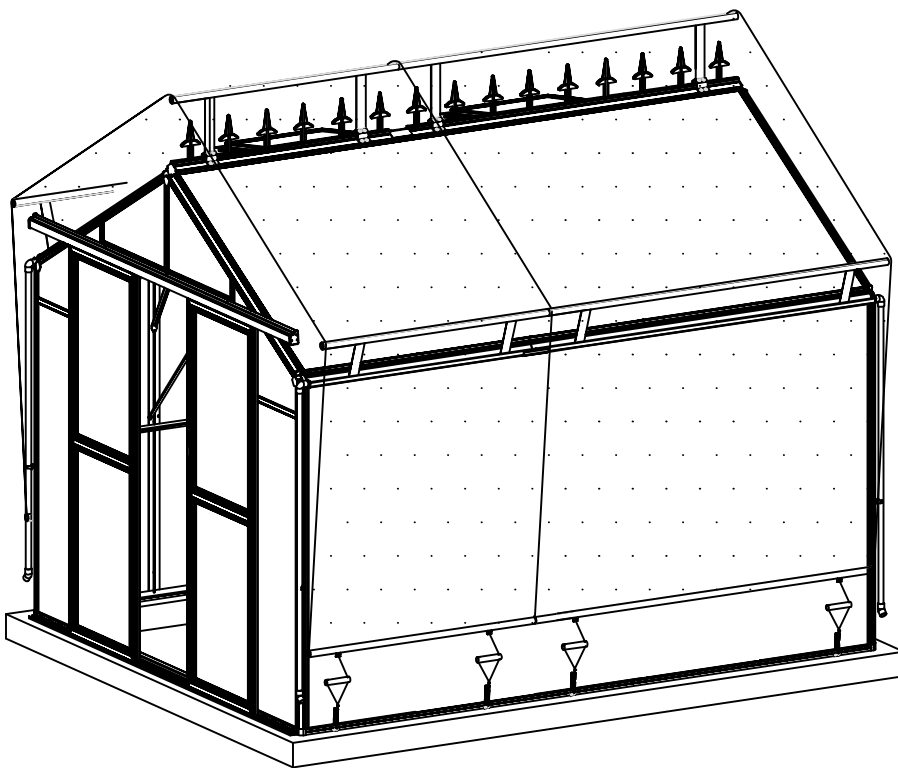

FOUR SEASON

Schattiernetz

Montage - Anleitung



FOUR SEASONS 100

















FOUR SEASONS 300

FOUR SEASONS 500

















FOUR SEASONS 700

Teileliste

Teilen für Four Seasons 100

Teil	Nr.	Zahl
	L01A	2
	L02A	5
	Y1	1
	L03A	2
	L03B	4
	W01	4
	W02	4
	W03	4
	W04	4
	W05	5
	W06	4
	W07	2
	S01 M6X16	8
	M01 M6	8
	Z01 Ø5X16	16
	Z02 Ø4X16	10
	J01	10

Teile Erweiterung

Teil	Nr.	Zahl
	L01B	2
	L02B	5
	Y2	1
	L03A	2
	L03B	4
	W01	4
	W02	4
	W03	4
	W04	4
	W05	5
	W06	4
	W07	2
	S01 M6X16	8
	M01 M6	8
	Z01 Ø5X16	16
	Z02 Ø4X16	10
	J01	10

Wichtig:

**Bitte lesen Sie diese Anleitung vor der Montage sorgfältig durch.



















**Bitte bewahren Sie diese Anleitung zum späteren Nachschlagen auf.

Benötigte Werkzeug:

*Schraubendreher

*Bohrmaschine

*Schraubenschlüssel

Teil	Nr.	Zahl
	L01A	2
	L02A	5
	Y1	1
	L01B	2
	L02B	5
	Y2	1
	L03A	4
	L03B	8
	W01	8
	W02	8
	W03	8
	W04	8
	W05	5
	W06	8
	W07	4
	S01 M6X16	16
	M01 M6	16
	Z01 Ø5X16	32
	Z02 Ø4X16	20

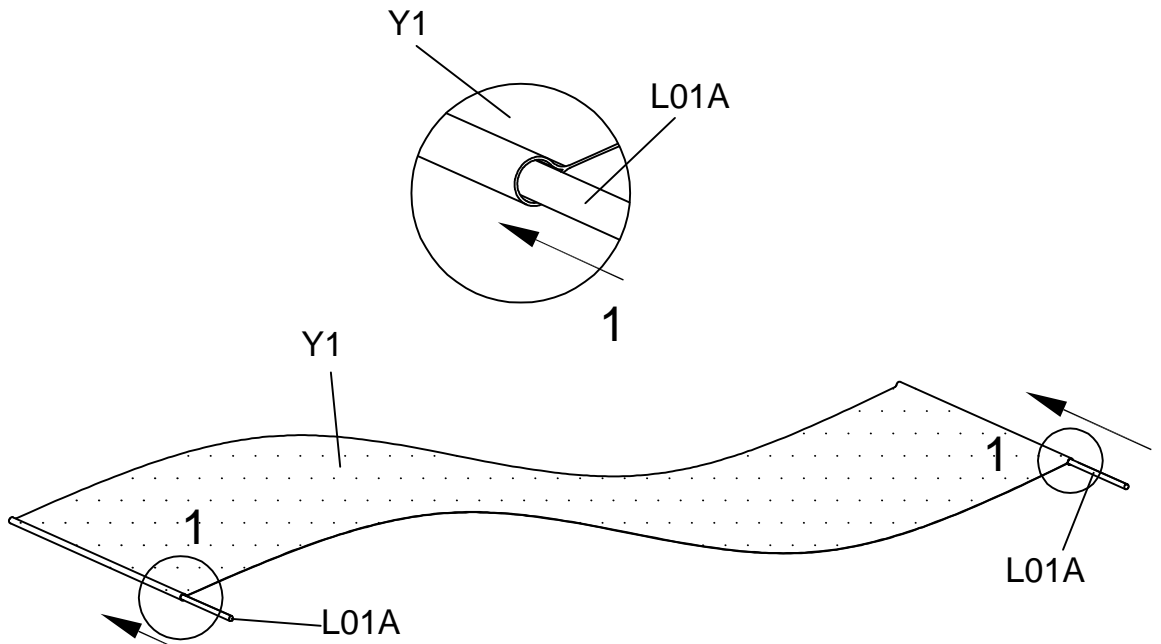

Stecken Sie L01A in den Saum des Schirmmaterials.

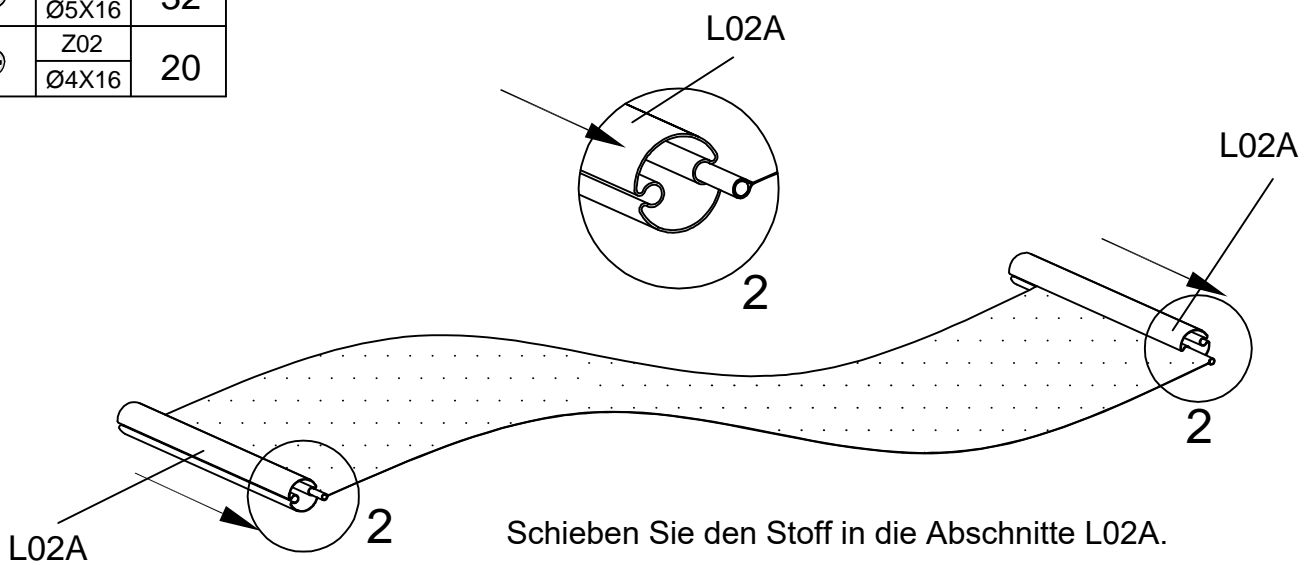

Schieben Sie den Stoff in die Abschnitte L02A.

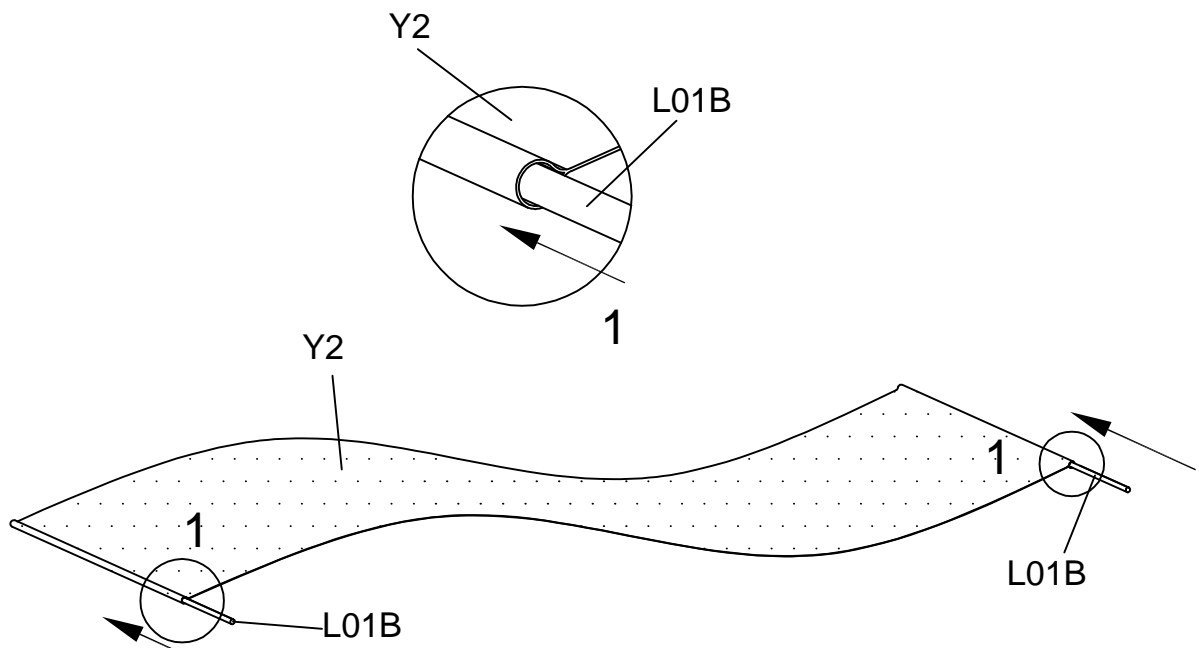

L01B in den Saum des Schattenstoffes einfügen.

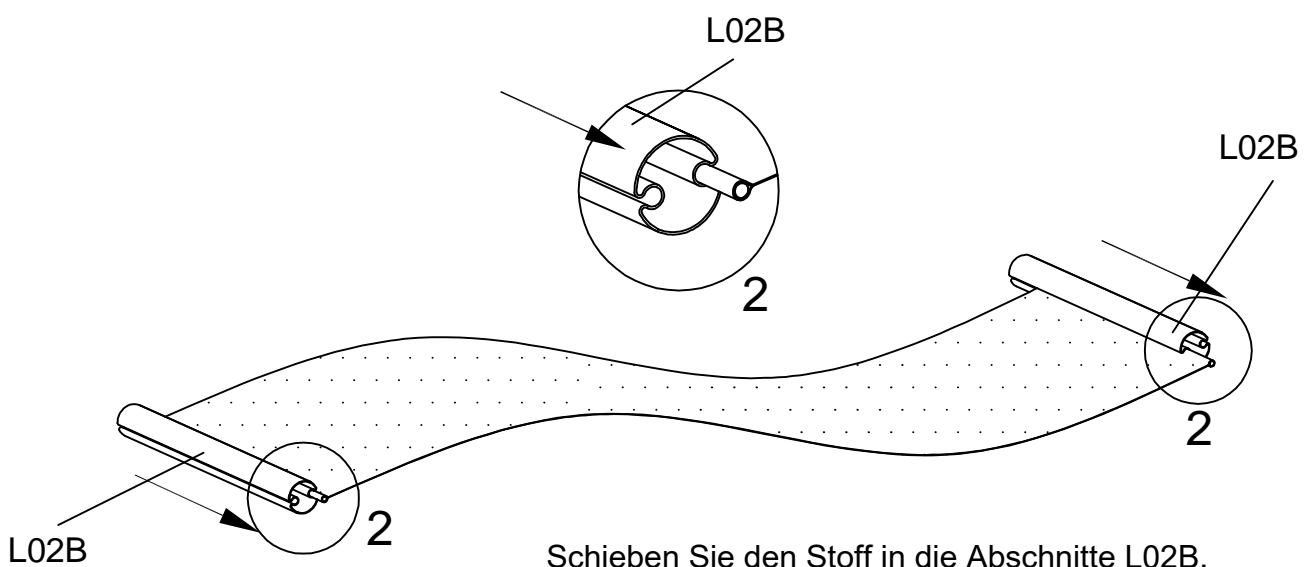

Schieben Sie den Stoff in die Abschnitte L02B.

Firstwinkel (L03A) und Traufwinkel (L03B) sollten 175 mm vom Ende jedes First- und Traufprofils entfernt sein. Bohren Sie 16 Löcher durch L03A & W07 in den Firststrahlen und ebenfalls 16 Löcher durch L03B in das Dachrinnen-/Fußprofil (siehe Abb. unten).

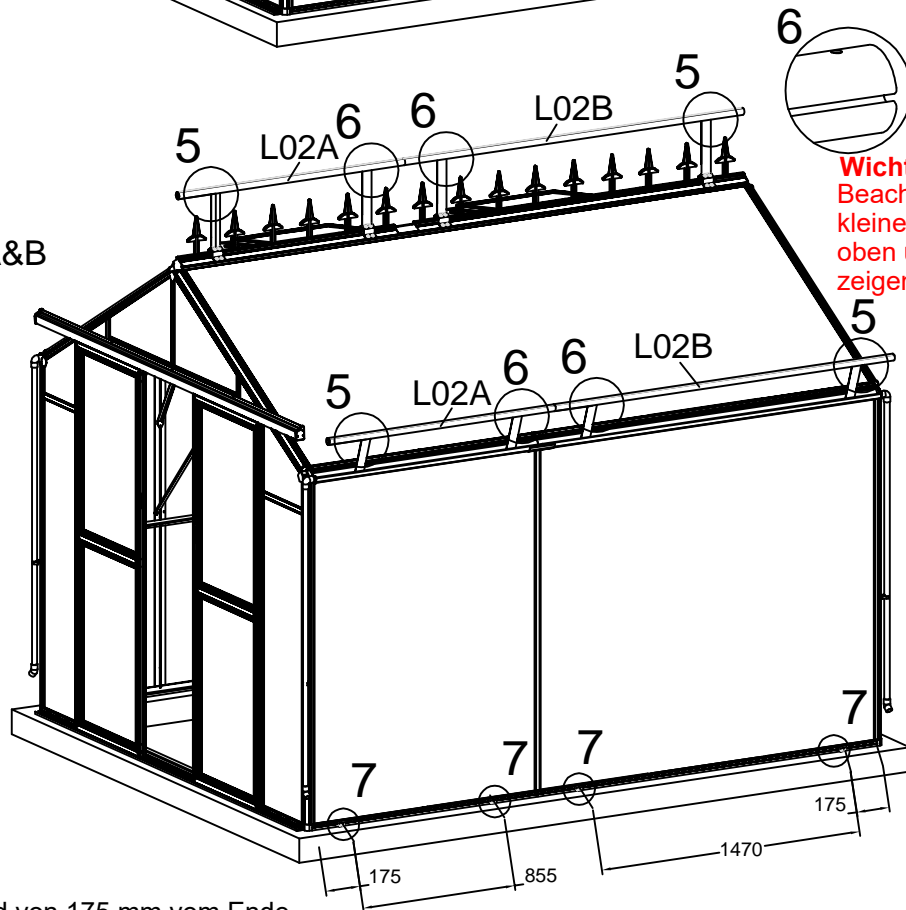
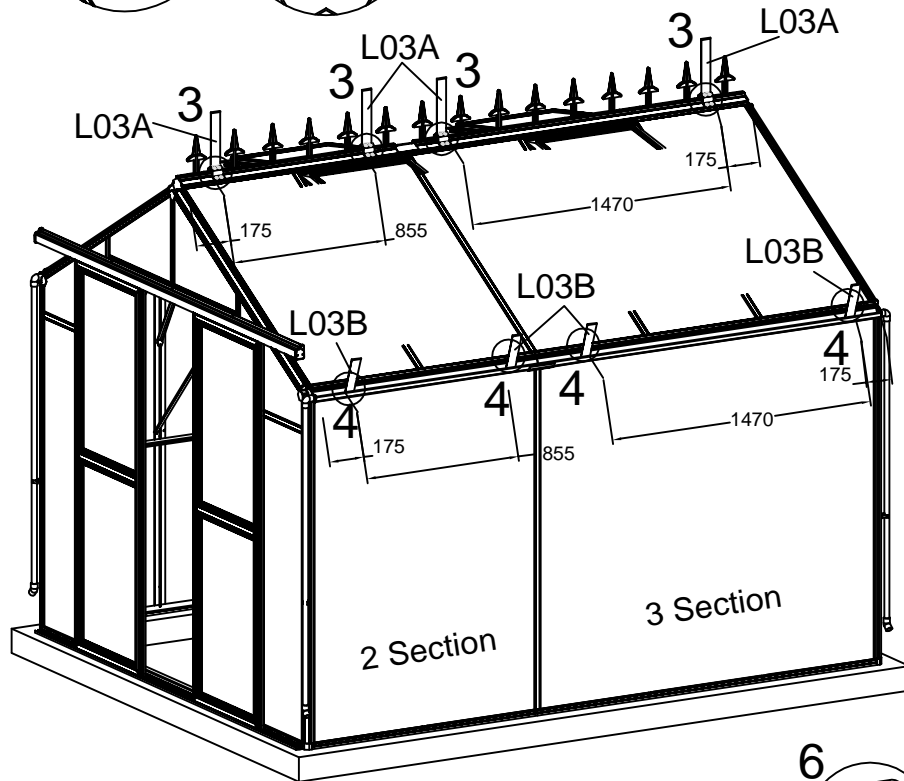
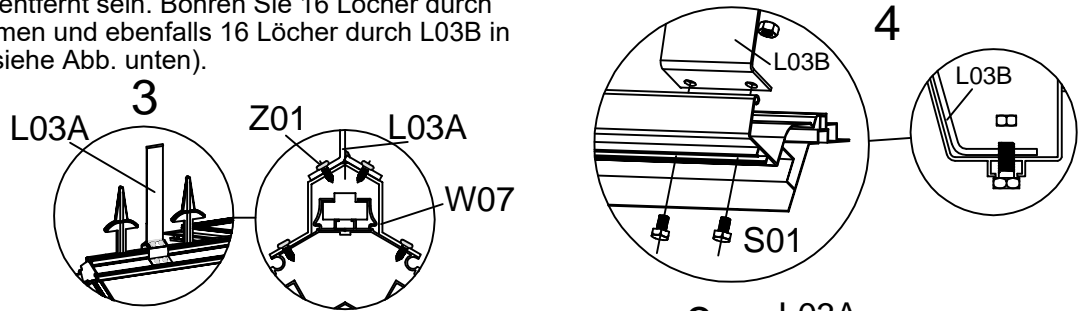

Wichtig! Beachten Sie dieses kleine Loch, das nach oben und rechts zeigen sollte.

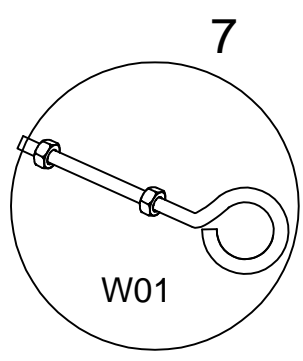
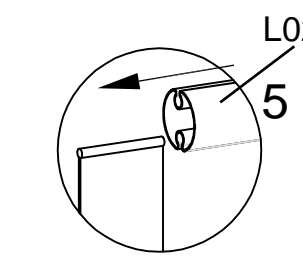

Setzen Sie ein W01 im Abstand von 175 mm vom Ende jedes Gewächshausbodens. Bohren Sie 16 Löcher, Dia. 6 mm, durch W01 in die Bodenprofile (siehe Abb. oben).

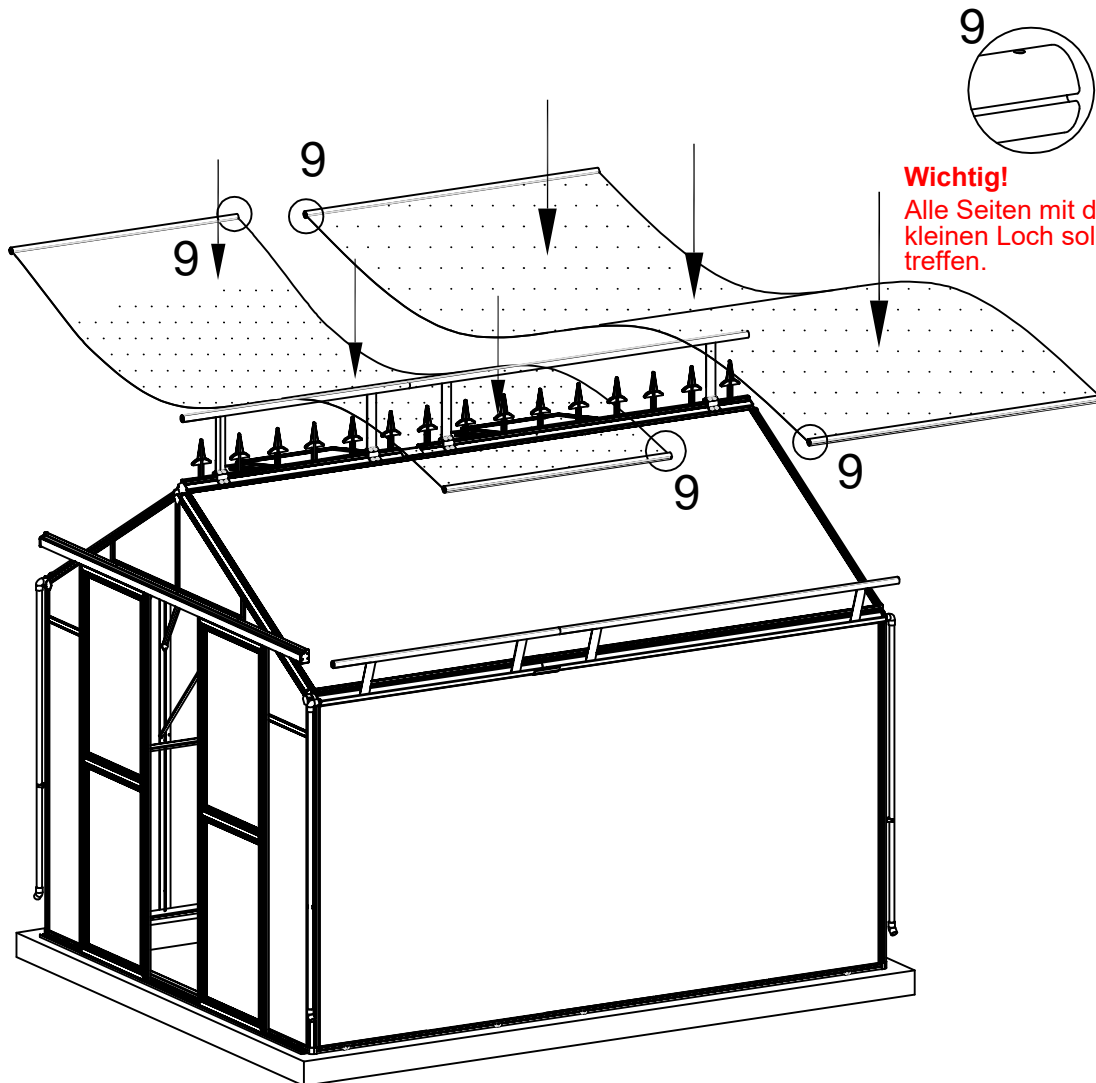
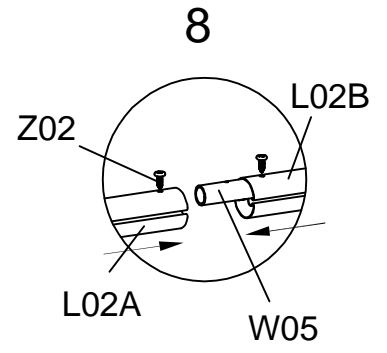
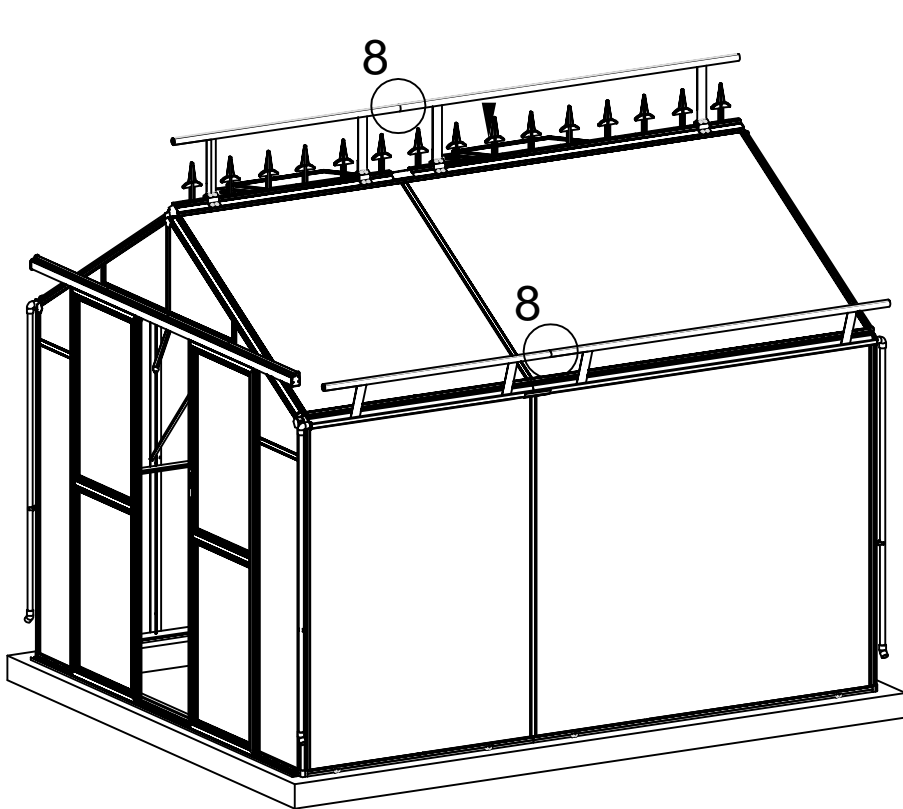

Wichtig!
 Alle Seiten mit diesem
 kleinen Loch sollten sich
 treffen.

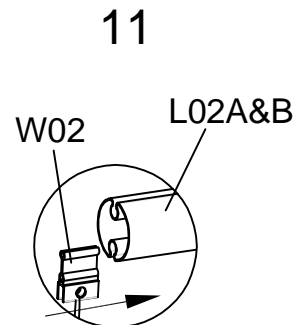
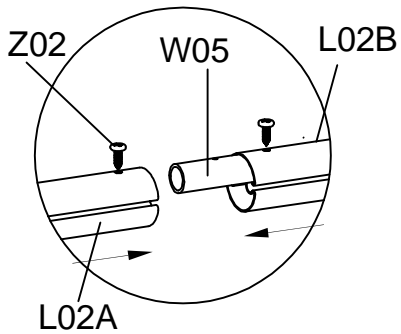
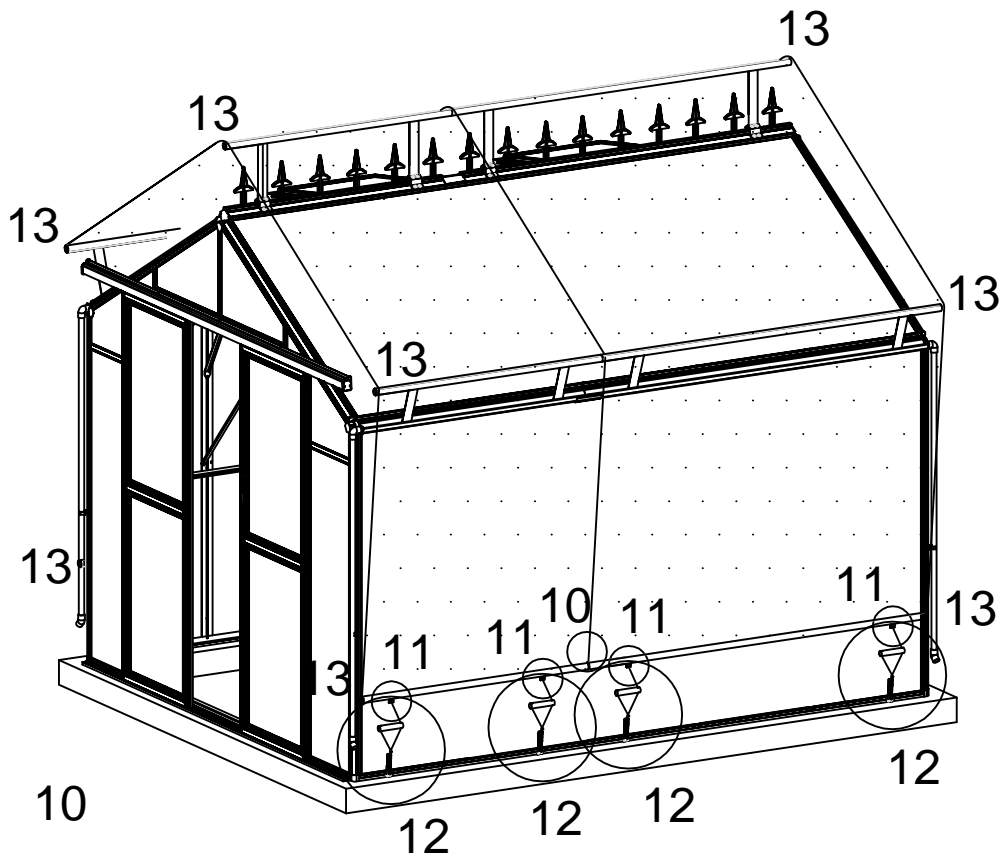

Stecken Sie das Teil W02 in die L02A&B an beiden Enden der Sonnenschutzstange. Bringen Sie dann den Seil- und Federspanner W03 an, um das Schattentuch fest zu fixieren. Es ist wichtig, dass das Schattentuch straff über dem Gewächshaus liegt. Wiederholen Sie diesen Vorgang auf der anderen Seite des Gewächshauses.

